

Frontplattenausschnitt (Rückseite)
Panel cut out (rear side)

Print-Bohrplan (Bestückungsseite)
PCB-Layout (component side)

min. Einbauabstand
min assembling distance

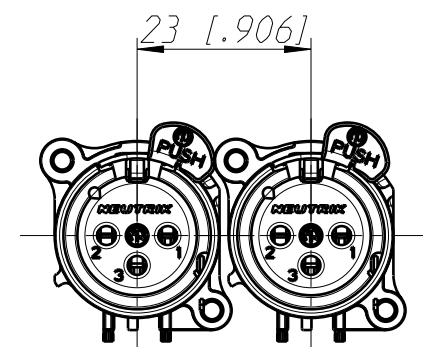
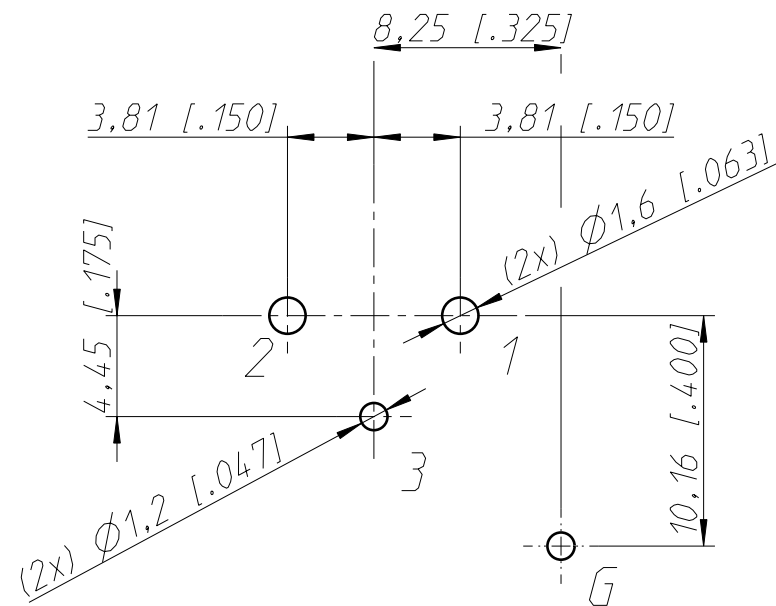
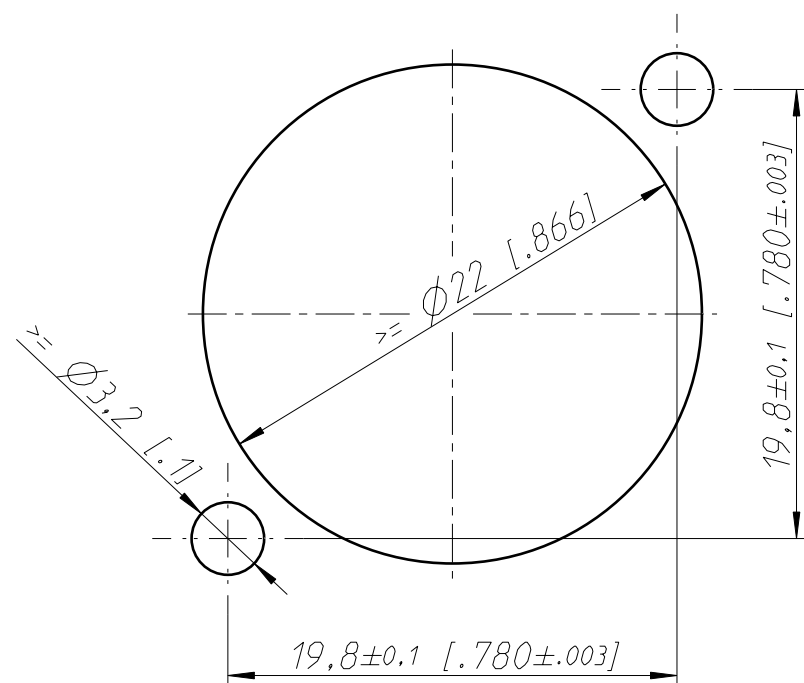

1:1

General tolerances ISO 2768-m	Scale	Date	Name
Refer to protection notice ISO 16016.	3:1 (A3)	17.05.17	Karlinger
Name	NC3FAV	Modified	-
	NC3FAV2-DA	Change-No.	Sheet-No.
		-	1 / 1
		Index	-
Replacement for:		Drawing-No.	
NEUTRIK		ST-NC3FAV2-DA	